

poligon®



poligon.com



Gable Roof 52x119
#55932

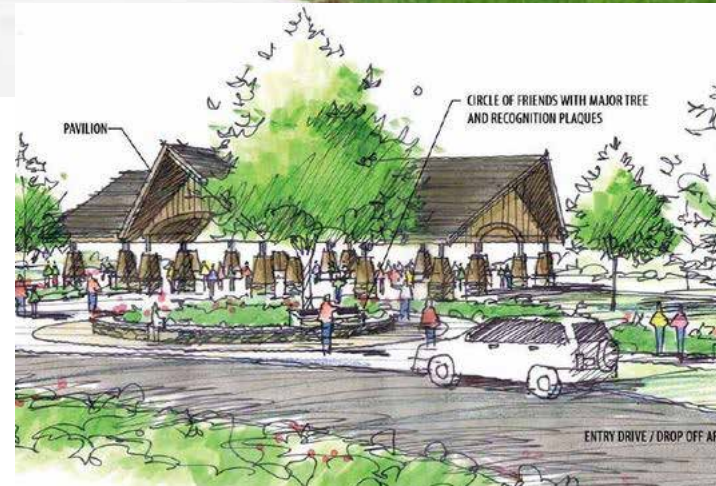

The Poligon® Advantage

Since 1964

Poligon is the leader in the design, engineering, and manufacturing of open air structures. From your initial design concept through the completed installation, our streamlined process makes creating the perfect structure for your site easy and efficient.

Poligon offers endless options to suit your site-specific requirements. Our experienced design and engineering teams ensure all structures are building code compliant and detailed for easy installation. Our state of the art manufacturing facility and dedicated staff fabricate each structure with the highest precision and quality in the industry. Every structure is protected in our Poli-5000 powder coat for many years of superior durability.

Expect the best.

Table of Contents

Poligon® Process	2-3	Squares	
Customer Inspired Designs	4-9	Carnival	52
Total Park Package	10-11	Crossing	53
Athletic Complexes	12-15	Square	54-55
Farmers Markets	16-17	Small Shelters	
Amphitheaters	18-21	Sun Shelters	56
Trellises	22-25	Kiosk	57
Walkway Covers	26-29	Portal	57
Parking Canopies	30-31	Dugout	58
		Privacy Shelter	59
Specialty		Poligon Fabric	60-61
Gullwing	32	Poligon Wood	62-63
Leaf	33	Line Drawings	64-80
Monoslope	34-35	Reference	
Northern Skyline	36	Assembly	81
Arch	37	Picnic Table Capacity	82
		Shelter Nomenclature	82
Dodecagons		LEED Points	83
Large Pavilions	38-39	Options	
Octagons		Railing/Ornamentation	84
Carmel	40	Gable Ornamentation	85
Octagon	41	Columns	86
		Column Base	87
Hexagons		Electrical Cutouts	87
Oxford	42-43	Glider	88
Grand Haven	44	Equipment Enclosures	89
Tiara	44	Low Reveal Clerestory	90
Hexagon	45	Cupolas	90
		Powder Coat	91
Rectangles		Roof Options	92-93
Marquee	46		
Chelsea	47		
Gable Roof	48-49		
Hip Roof	50-51		

Poligon® Process

1 Initial Contact - Contact your local Poligon Representative and we'll begin the discovery process. We will discuss your objectives, timelines, budgets, and most importantly what you need for your project.

2 Design - You can collaborate directly with our design professionals, leveraging our decades of experience to turn your design intent into a reality.



3 Stamped Engineering Drawings - Our in-house engineering team is able to provide structural calculations and drawings that are signed, sealed, and ready for the permitting process, saving time and additional costs.

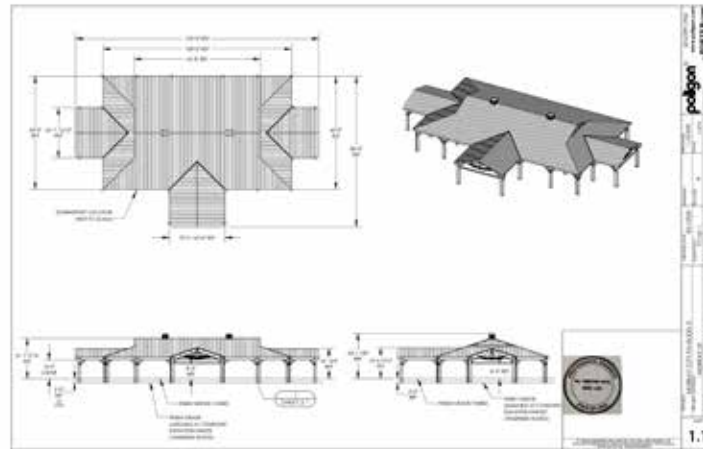

4 Material Procurement & Fabrication - Framing and roofing materials procured through Poligon streamlines the process, reduces coordination issues, and progresses your project through the manufacturing stage more quickly.

All structures are manufactured in our AISC (American Institute of Steel Construction) and AWS (American Welding Society) certified facility. AISC sets the quality standard for structural steel and is the most recognized national quality certification program in the industry.



American Welding Society



5 Powder Coating - Finished parts receive our exclusive in-house Poli-5000™ powder coating, the toughest most durable coating in the industry and Powder Coat Institute (PCI) 4000 certified.



6 Packaging & Shipping - Components are inspected throughout the manufacturing process and then inspected again prior to being carefully packaged. Finally, your shipment is sent and delivered on dedicated flatbed trucks so you never have to worry about damage along the way.



7 Installation - Poligon's structural steel frames bolt together and do not require field welding or cutting of steel members. In addition to eliminating bird nesting, our framing system conceals the structural hardware (bolts, nuts, etc.)



8 Ongoing Support - Throughout the process, Poligon's single source responsibility improves communication and ensures that any unforeseen issues get resolved quickly and cost effectively.



Customer Inspired Designs



Monoslope 20x38
#56330



Gable -Tiered 42x70
#55646



Barrel Vault 10x20
#59200



TriLeaf 25x30
#66355



Inverted Gable 58x41
#60044

Every Polygon structure is designed specifically for your site. Creative details such as painted artwork can also be applied by others to customize the structure for your community.



Inverted Gable 49x78
w/ graphics by others
#63657

Customer Inspired Designs



Monoslope 30x40
#63877



Gable-Tiered 45x105
#64406



Hip 20x20
#51801



Monoslope 16x20
#64526



Hip Roof 13x26
#64965



Gable-Tiered 36x36 & 12x12
#61012, 61011



Neo Classic 28
#51982

Customer Inspired Designs



Monoslope 22x28
#58785



Trellis 23x34
#59526



Inverted Gable 35x65
#62399



Monoslope 24x24
#64249



Hip Roof 31x38
#68875



Barrel Vault 40x80
#55343

Total Park Package

Frisbie Park - Rialto, CA



Carnival 24
#59639



Trellis 12x44
#59634



Cantilevered Walkway Cover 10x16
#62554



Cantilevered Walkway Cover 14x30
#62555



Curved Trellis 12x92
#58961



Lantern 24
#59635



Chelsea 16x24
#62548

Several different structures were designed for Frisbie Park to provide appropriate shade and coverage for each area. The coordinating colors and styles make this facility both eye-catching and practical for many hours of entertainment both day and night.

Athletic Complexes



Monoslope 21x152
#57061

Coordinate your athletic complex with a variety of Poligon structures, including dugouts, bleacher covers, concession pavilions, restroom covers, lounge areas, kiosks, and more.



Gable Roof 56x118
#55458



Dugout 10x32
#57444



Cantilevered Walkway Cover 14x38
#66334

Athletic Complexes



Gullwing Walkway Cover 8x12
#64321



Gable Roof Sun Shelter
#55138



Monoslope 42x32
#67419



Barrel Vault 18x73
#57103



Carnival 30
#57941



Monoslope 24x37
#65134

Farmers Markets



Nested Crossing 40x169
#58381



Gable-Tiered 30x228
#63582



Barrel Vaults 40x60
#51422

Amphitheaters

Standard design details on page 64



Kokomo 30x25
#51641



Constellation 40x30
#55896



Houston 54
#59516

616.888.3500



Monoslope 55x60
#53081



Constellation 40x20
#68598

Amphitheaters

Standard design details on page 64



Amphitheater 63x46
#56416



Amphitheater 35x25
#62534



Barrel Vault 37x27
#52578



Wave Amphitheater 25x40
#64188



Amphitheater 42
#57396

Trellises

Standard design details on page 65



Curved Millenium Trellis 9x28
#55283



Trellis 76 x10
#61570



Trellis 14x58
#52827

616.888.3500



Trellis 49
#56228

poligon.com

Trellises

Standard design details on page 65



Trellis 24x65
#59196



Trellis w/ Artisan Wood 18x18
#64995



Trellis 13x114
#63810



Trellis 26x68
#64752



Santa Fe Trellis 10x20
#59804

Trellis canopies are available in a variety of materials, including metal, wood, polycarbonate, and laser-cut panels.

Walkway Covers

Standard design details on page 66



Cantilevered Walkway Cover 14x247
#55391



Cantilevered Walkway Cover 7x25
#59666



Cantilevered Walkway Cover 14x56
#59252



Cantilevered Walkway Arched 12x36
#60194

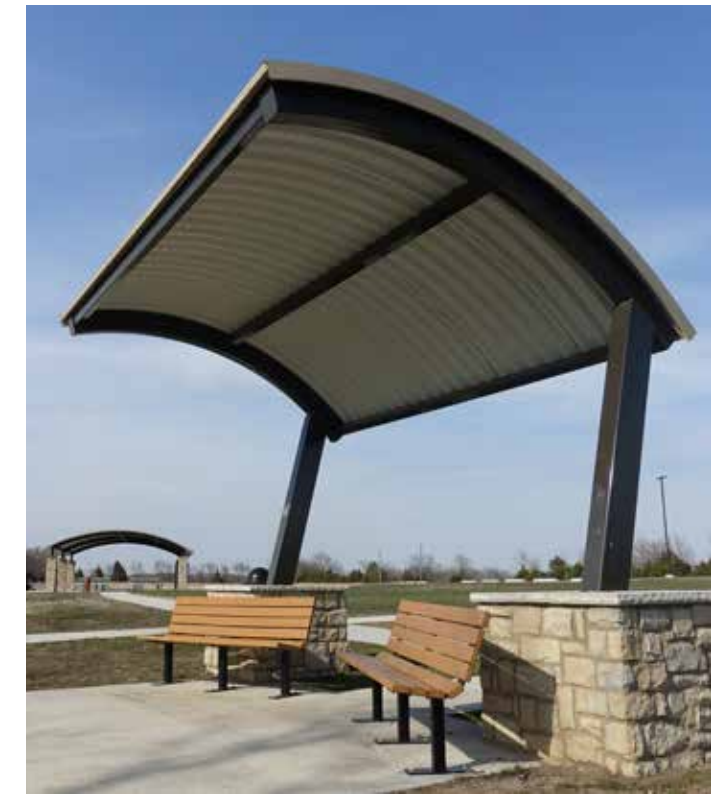

Cantilevered Walkway Barrel Vault 11x15
#57480



Cantilevered Walkway Cover 18x34 w/ laser-cut panels
#62566

poligon.com

Walkway Covers

Standard design details on page 66



Inverted Gable 10x32
#62728



Walkway 15x700
#55390



Walkway 12x422
#62502

Cladding for walkway covers is available in a variety of materials, including metal, wood, polycarbonate, and laser-cut panels.



Walkway 8x366
#63633



Walkway 8x366
#63633

Parking Canopies



Monoslope 43x90
#57780



Monoslopes 28x73, 28x36, 30x37
#67600



Monoslope 17x109
#55570

616.888.3500



Northern Skyline 53x133
#63949

poligon.com

Gullwing (GUL) / (GWC)

Standard design details on page 67



GUL 24x24
#64763



GUL 24x24
#60527



GUL 24x24
#64681

Leaf (LEF)

Standard design details on page 68



LEF w/ laser-cut panels 8x14
#66359



LEF 10x13
#59160



LEF 16x30
#62434

Monoslope (MSL)

Standard design details on page 68



MSL 20x30
#68963



Monoslope 25x84
#67442



MSL 22x22
#66504



MSL 24x16
#60153



Monoslope 30x32
#65537



Monoslope 26x100
#65857

Northern Skyline (NSL)

Standard design details on page 69



NSL 20x40
#58445



NSL 20x24
#58986



NSL 24x34
#64818

Arch (ARC)

Standard design details on page 69



ARC 16x33
#53164



ARC 20x21
#61535



ARC 30x30
#61468

Large Pavilions (PLC/PVA)

Standard design details on page 70



PLC 66 w/ optional cupola
#48205



PVA 86
#46134



PLC 94
#64938



PVA 80
#66520



Carmel (GCO2)

Standard design details on page 71



GCO2 24
#66930

Octagon (OTC)

Standard design details on page 71



OTC 46 w/ optional cupola
#55134



GCO2 26
#55727



GCO2 32
#57110



OTC 28
#55796



GXO2 36
#55537



GXO 18
#59471



GXO2 28 w/ optional cupola
#47688



GXO2 28 w/ optional cupola
#53097



GXO 14
#62139



GXO 18
#63120

Grand Haven (GHX)

Standard design details on page 73



GHX 40
#55340



GHX 28
#64731

Tiara (TIA)

Standard design details on page 73



TIA 30x44
#67422



TIA 30x44
#67274

Hexagon (HXE)

Standard design details on page 74



HXE 24
#65806



HXE 32
#61440



HXE 40
#57566

Marquee (MAR)

Standard design details on page 74



MAR 20x40
#69147



MAR 40x60
#64934

Chelsea (CHE)

Standard design details on page 75



CHE 28x68
#65988



CHE 40x57
#59041



CHE 40x60
#66787

Gable Roof (REK)

Standard design details on page 75



REK 30x75 w/ gable truss ornamentation
#62940



REK 50x125 w/ optional gable ornamentation
#51976



REK 30x44
#63257



REK 16x34
#63725



REK 24x34
#66946

Hip Roof (RAM)

Standard design details on page 76



RAM 30x44
#55802



RAM 40x64
#61088



RAM 20x44
#63161



RAM 30x50
#49253



RAM 30x64
#59877

Carnival (CAR)

Standard design details on page 76



CAR 30
#65550



CAR 12
#49137



CAR 20
#61822

Crossing (CRS)

Standard design details on page 77



CRS 24 w/ optional gable ornamentation
#58988



CRS 16 w/ optional cupola
#57466



CRS 24
#58988

Square (SQR)

Standard design details on page 77



SQR 30
#39564



SQR 30
#56169



SQR 30
#56169



SQR 42 w/ optional polycarbonate panels
#67085



SQR 20
#50091

Sun Shelters (SSG/SSH)

Standard design details on page 78



SSG 8x12 w/ optional backless metal bench
#55286



SSH 12x12
#48146



SSH 12x12
#48098

Kiosk (KSK)

Standard design details on page 79



KSK 3-8



KSK 1-8

Portal (PRT)

Standard design details on page 79



PRT 11 w/ optional lettered arch & medallion
#47989



PRT 23 w/ optional lettered arch & medallion
#56635

Dugout (DUG) *Fencing by others

Standard design details on page 80



DUG 10x32
#57444



DUG 14x55
#59051



DUG 10x24
#63195

Privacy Shelter (PLE, PRV)

Standard design details on page 80



PLE 6x15
#48887



PLE-HC1
#60547



PRV-S
#64442



Poligon Fabric structures allow full shade in fun artistic ways.

Each structure is designed with High Density Polyethylene (HDPE) Shade Fabric and offers professional grade architectural shade that blocks up to 98.8% of harmful UV sun rays. Fabric is also flame retardant and fade/tear resistant.

Visit our website for more fabric shade ideas.



Poligon Wood structures bring a natural look to your shelter and are available in a variety of stain colors and roofing options.

Visit our website for more wood shade ideas.

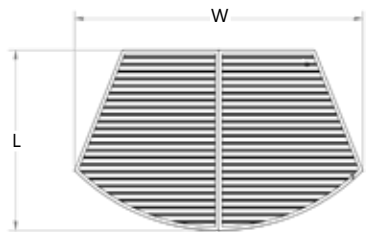

Kokomo

KMO (pg 18)

Suggested Sizes

BIN	W	L	SF
KMO	30'	25'	581
KMO	40'	25'	818
KMO	50'	25'	1032

Additional sizes available in 1' increments

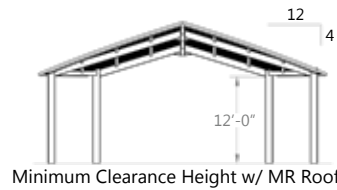

Minimum Clearance Height w/ MR Roof

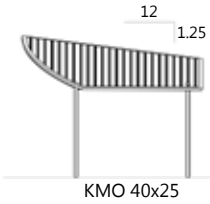

KMO 40x25

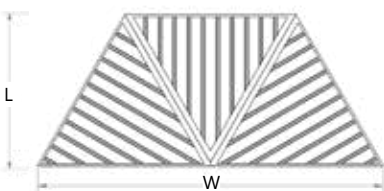

Houston

HHA (pg 18)

Suggested Sizes

BIN	W	L	SF
HHA	16'	7'	83
HHA	20'	9'	130
HHA	24'	11'	187
HHA	28'	13'	255
HHA	32'	14'	333

Additional sizes available in 1' increments



HHA 24'

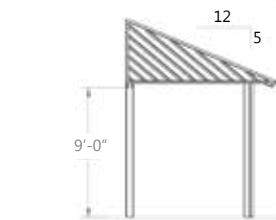

Minimum Clearance Height w/ MR Roof

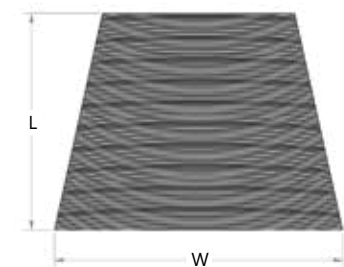

Constellation

CST (pg 19)

Suggested Sizes

BIN	W	L	SF
CST	30'	20'	500
CST	40'	30'	1000

Additional sizes available in 1' increments



CST 40x30

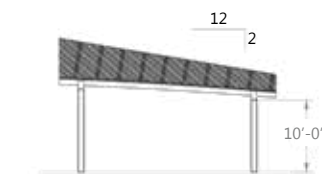

Minimum Clearance Height w/ MG Roof

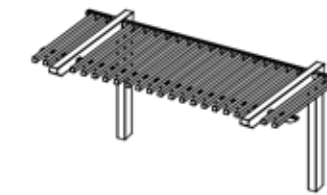
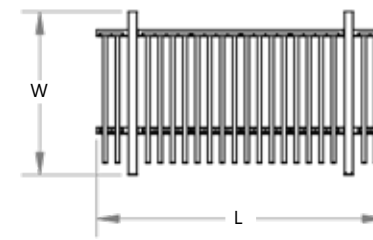

Millennium Trellis

MIL (pg 22)

Suggested Sizes

BIN	W	L	SF
MIL	9'	16'	144
MIL	9'	28'	252
MIL	9'	40'	360

Additional sizes available in 1' increments



MIL 9x16



Minimum Clearance Height

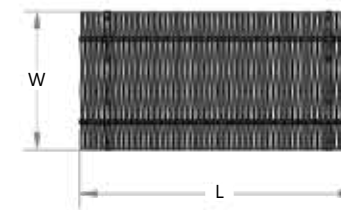

Santa Fe Trellis

SFE (pg 25)

Suggested Sizes

BIN	W	L	SF
SFE	10'	10'	100
SFE	10'	20'	200
SFE	10'	30'	300
SFE	10'	40'	400
SFE	20'	20'	400
SFE	20'	30'	600
SFE	20'	40'	800

Additional sizes available in 1' increments



SFE 10x20



Minimum Clearance Height

Steel Latilla & Truss End Options

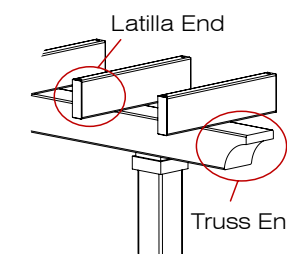

Modern



Mission



Mediterranean



Metro



Tuscan



Architectural



Santa Fe (truss end only)

Artisan Wood Options

Poligon Artisan Wood structures uniquely combine the natural warmth of wood trellis members (latilla) with the strength and durability of steel supporting framework. Wood is available in multiple options, including IPE, Mahogany, Cedar, and Accoya.

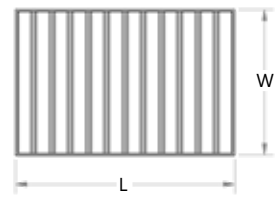

Covered Walkway Cantilevered

CWC (pg 26)

Suggested Sizes

BIN	W	L	SF
CWC	8'	12'	96
CWC	8'	16'	128
CWC	8'	20'	160
CWC	10'	12'	120
CWC	10'	16'	160
CWC	10'	20'	200

Additional sizes available in 1' increments

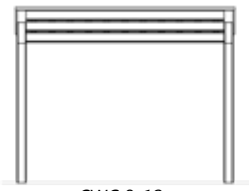

CWC 8x12

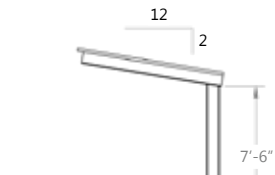

Minimum Clearance Height w/ MR Roof

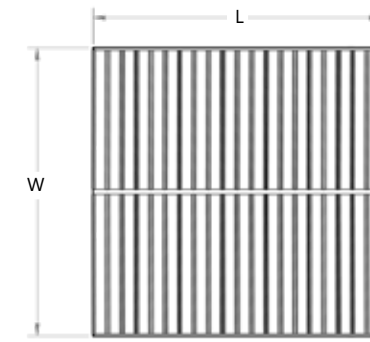

Gullwing

GUL (pg 32)

Suggested Sizes

BIN	W	L	SF
GUL	20'	20'	400
GUL	24'	24'	576
GUL	30'	30'	900

Additional sizes available in 1' increments

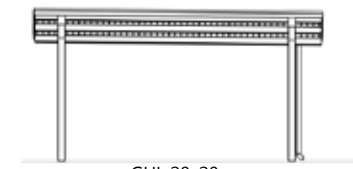

GUL 20x20

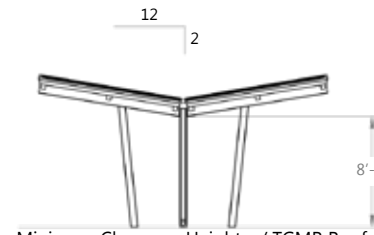

Minimum Clearance Height w/ TGM Roof

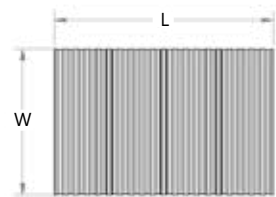

Covered Walkway Arched

CWA (pg 27)

Suggested Sizes

BIN	W	L	SF
CWA	8'	12'	96
CWA	8'	18'	128
CWA	8'	24'	160
CWA	10'	12'	120
CWA	10'	18'	180
CWA	10'	24'	240

Additional sizes available in 1' increments

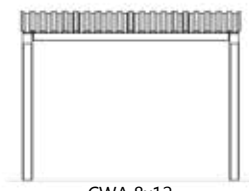

CWA 8x12



Minimum Clearance Height w/ MG Roof

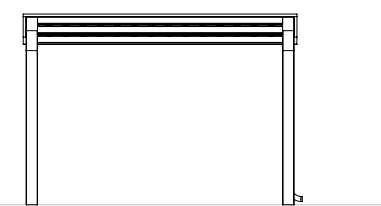
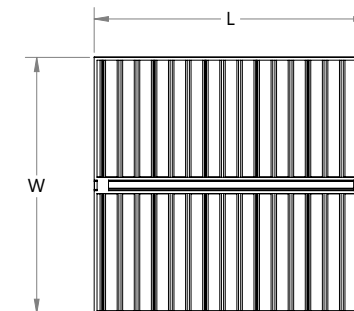

GWC 15x16
Shown w/ Internal Downspout

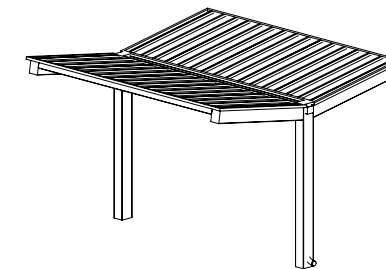

Gullwing Walkway Cantilevered

GWC (pg 14)

Suggested Sizes

BIN	W	L	SF
GWC	15'	12'	180
GWC	15'	16'	240
GWC	15'	20'	300

Additional sizes available in 1' increments

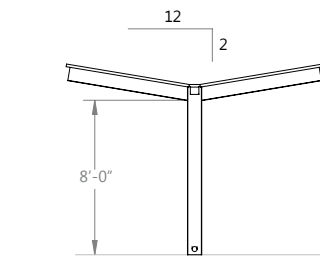

Minimum Clearance Height w/ MR Roof

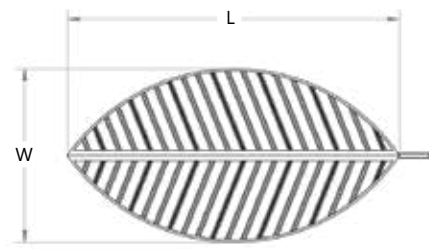

Leaf

LEF (pg 33)

Suggested Sizes

BIN	W	L	SF
LEF	8'	14'	88
LEF	12'	23'	216
LEF	16'	30'	377
LEF	20'	38'	597

Additional sizes available in 1' increments

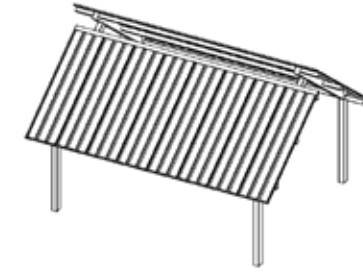
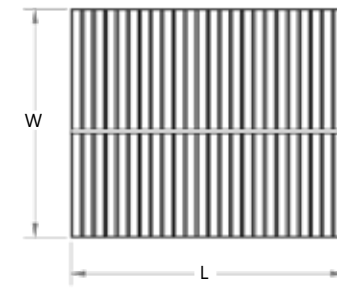
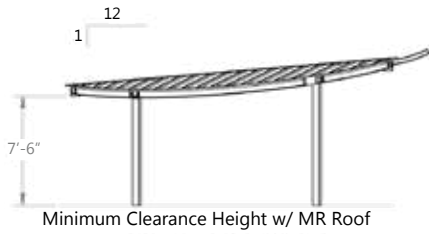

Northern Skyline

NSL (pg 36)

Suggested Sizes

BIN	W	L	SF
NSL	20'	24'	480
NSL	24'	34'	816
NSL	30'	34'	1020
NSL	30'	50'	1500

Additional sizes available in 1' increments

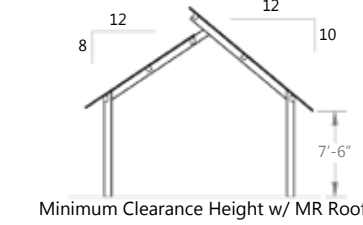

Monoslope

MSL (pg 35)

Suggested Sizes

BIN	W	L	SF
MSL	10'	21'	210
MSL	16'	30'	480
MSL	20'	30'	600
MSL	26'	30'	780

Additional sizes available in 1' increments

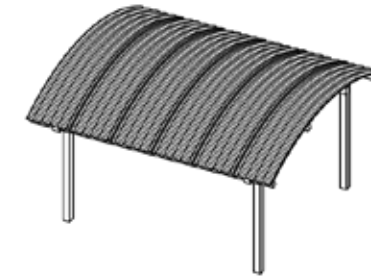
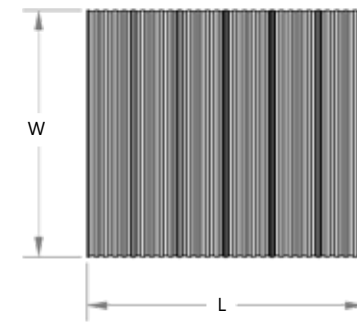
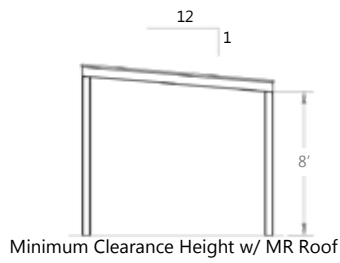
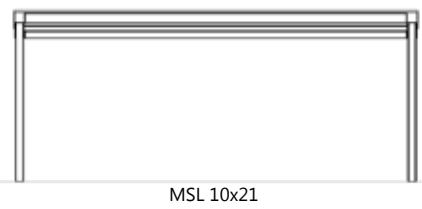
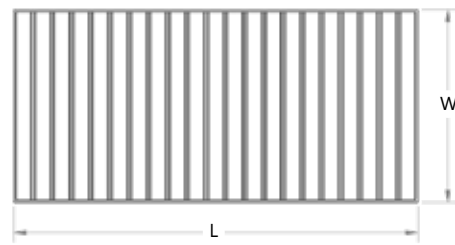

Arch

ARC (pg 37)

Suggested Sizes

BIN	W	L	SF
ARC	12'	12'	144
ARC	16'	18'	288
ARC	16'	33'	528
ARC	20'	21'	420
ARC	20'	30'	600
ARC	20'	39'	730
ARC	30'	30'	900

Additional sizes available in 1' increments

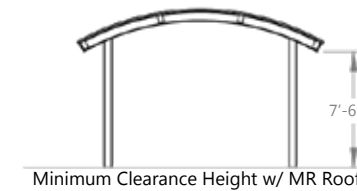
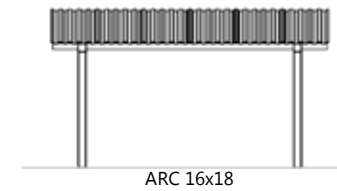

Clerestory Pavilion

PLC (pg 38)

Suggested Sizes

BIN	Size	SF
PLC	50'	1875
PLC	60'	2700
PLC	66'	3267
PLC	72'	3888
PLC	86'	5547

Additional sizes available in 1' increments

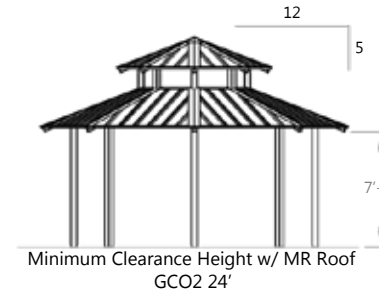
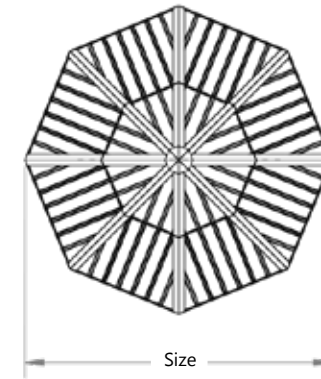
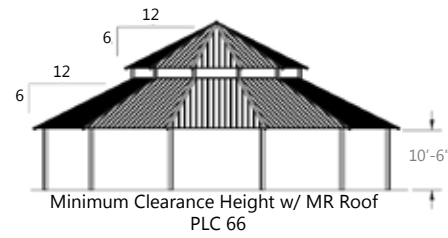
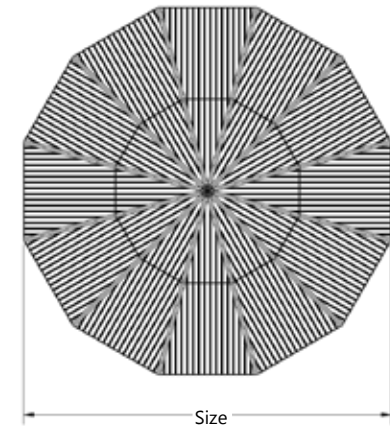

Carmel

GCO2 (pg 40)

Suggested Sizes

BIN	Size	SF
GCO2	20'	283
GCO2	24'	407
GCO2	28'	554
GCO2	32'	724

Additional sizes available in 1' increments

Pavilion

PVA (pg 39)

Suggested Sizes

BIN	Size	SF
PVA	40'	1200
PVA	50'	1875
PVA	60'	2700
PVA	66'	3267
PVA	72'	3888
PVA	86'	5547

Additional sizes available in 1' increments

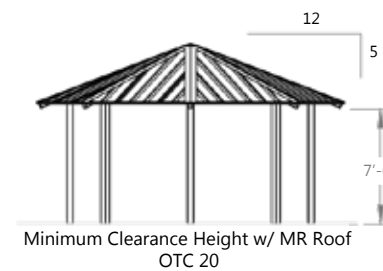
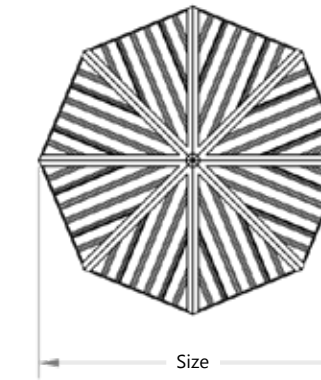
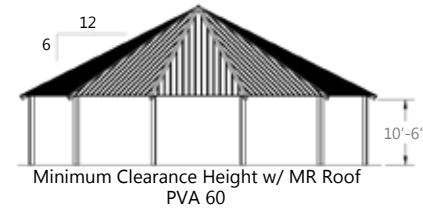
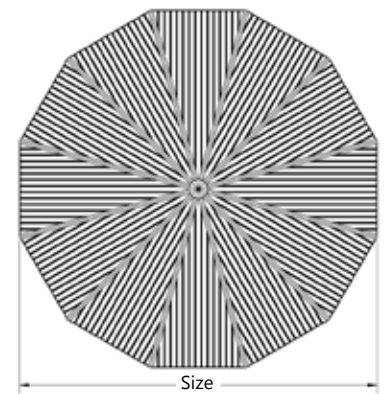

Octagon

OTC (pg 41)

Suggested Sizes

BIN	Size	SF
OTC	16'	181
OTC	20'	283
OTC	24'	407
OTC	28'	554
OTC	32'	724
OTC	40'	1131
OTC	48'	1629
OTC	58'	2379
OTC	64'	2896

Additional sizes available in 1' increments

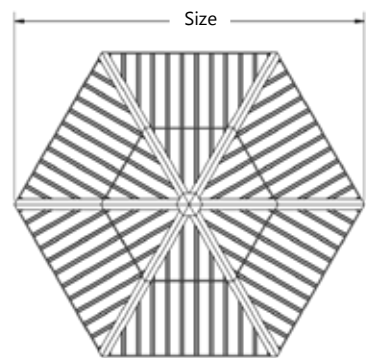

Minimum Clearance Height w/ MR Roof

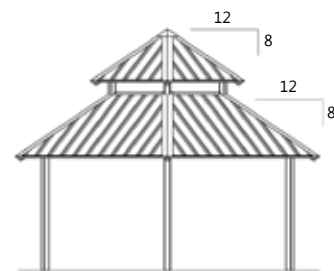

GCO2 24

Clerestory Oxford

GXO2 (pg 42)

Suggested Sizes

BIN	Size	SF
GXO2	24'	374
GXO2	28'	509
GXO2	32'	665
GXO2	40'	1039
GXO2	48'	1496
GXO2	58'	2185
GXO2	64'	2660
GXO2	76'	3752

Additional sizes available in 1' increments

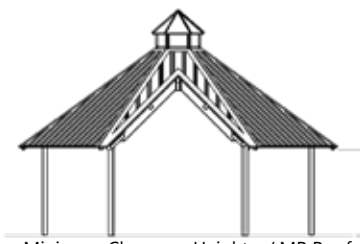
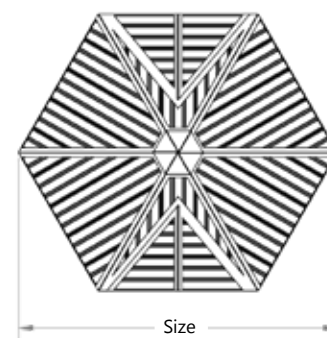

Minimum Clearance Height w/ MR Roof

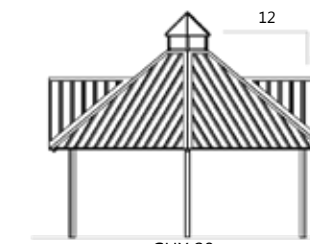

GHX 28

Grand Haven

GHX (pg 44)

Suggested Sizes

BIN	Size	SF
GHX	24'	374
GHX	28'	509
GHX	32'	665

Additional sizes available in 1' increments
Gable pitch 12:12

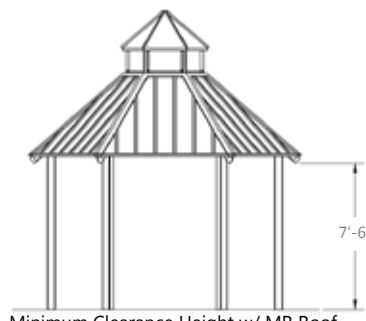
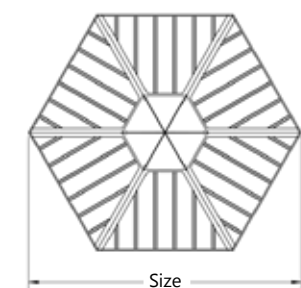

Minimum Clearance Height w/ MR Roof

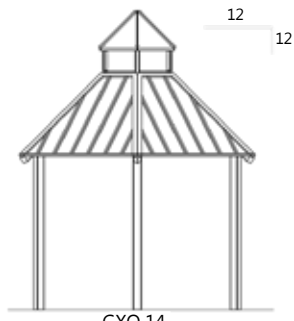

GXO 14

Oxford

GXO (pg 43)

Suggested Sizes

BIN	Size	SF
GXO	14'	127
GXO	18'	210
GXO	22'	314

Additional sizes available in 1' increments

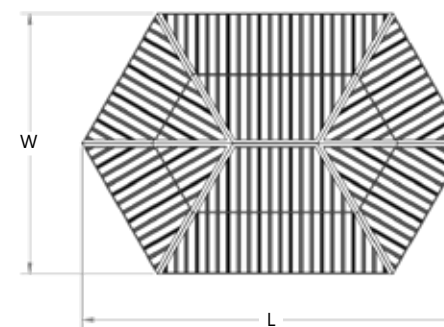

Minimum Clearance Height w/ MR Roof

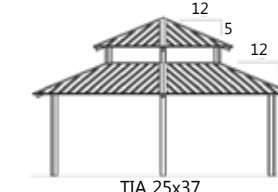

TIA 25x37

Tiara

TIA (pg 44)

Suggested Sizes

BIN	W	L	SF
TIA	15'	24'	300
TIA	17'	26'	358
TIA	20'	29'	500
TIA	25'	37'	744
TIA	30'	44'	1125
TIA	31'	46'	1148
TIA	35'	51'	1531

Additional sizes available in 1' increments

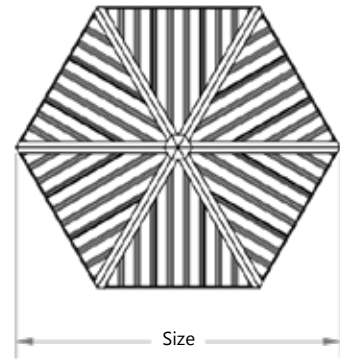

Hexagon

HXE (pg 45)

Suggested Sizes

BIN	Size	SF
HXE	16'	166
HXE	20'	260
HXE	24'	374
HXE	28'	509
HXE	32'	664
HXE	36'	842
HXE	40'	1039
HXE	48'	1496
HXE	58'	2185
HXE	64'	2660

Additional sizes available in 1' increments



HXE 20

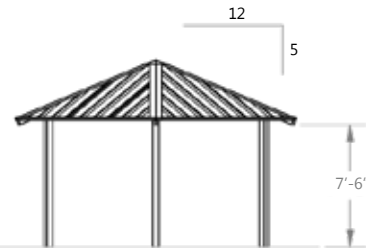

Minimum Clearance Height w/ MR Roof

32' and larger goes to 3.5:12 pitch

Chelsea

CHE (pg 47)

Suggested Sizes

BIN	W	L	SF
CHE	16'	24'	384
CHE	16'	34'	544
CHE	20'	24'	480
CHE	20'	34'	680
CHE	24'	34'	816
CHE	24'	44'	1056
CHE	24'	64'	1536
CHE	30'	34'	1020
CHE	30'	44'	1320

Additional sizes available in 1' increments

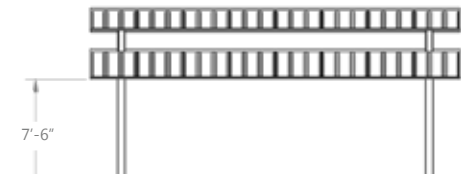
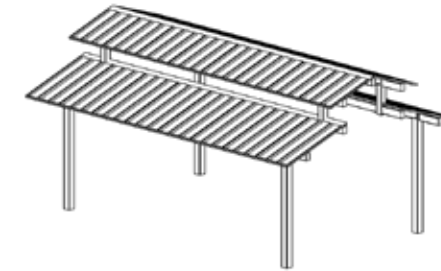
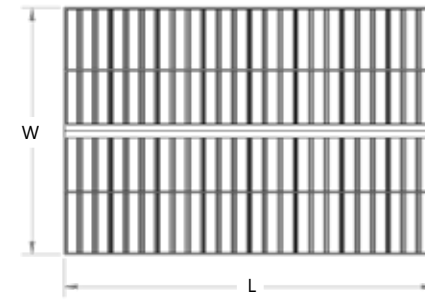

Minimum Clearance Height w/ MR Roof

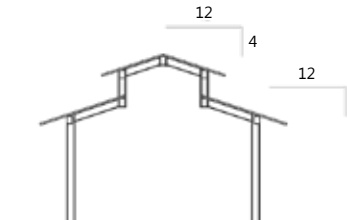

CHE 16x24

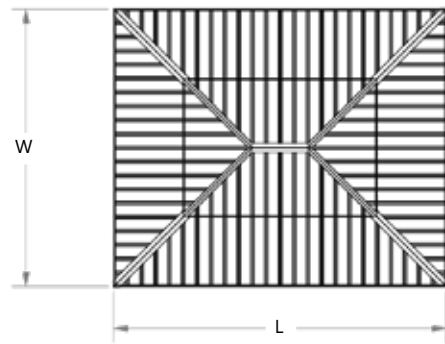

Marquee

MAR (pg 46)

Suggested Sizes

BIN	W	L	SF
MAR	14'	24'	336
MAR	20'	24'	480
MAR	24'	34'	816
MAR	30'	34'	1020
MAR	40'	44'	1760

Additional sizes available in 1' increments



MAR 20x24

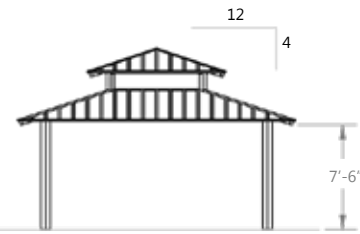

Minimum Clearance Height w/ MR Roof

Gable Roof

REK (pg 48-49)

Suggested Sizes

BIN	W	L	SF
REK	8'	9'	72
REK	8'	16'	128
REK	8'	24'	192
REK	16'	24'	384
REK	16'	34'	544
REK	16'	44'	704
REK	16'	64'	1024
REK	20'	24'	480
REK	20'	34'	680
REK	20'	44'	880
REK	20'	64'	1280
REK	24'	24'	576
REK	24'	34'	816
REK	24'	44'	1056

REK	24'	64'	1536
REK	24'	84'	2016
REK	30'	34'	1020
REK	30'	44'	1320
REK	30'	64'	1920
REK	30'	84'	2520
REK	30'	104'	3120
REK	40'	44'	1760
REK	40'	64'	2560
REK	40'	84'	3360
REK	40'	104'	4160
REK	50'	64'	3200
REK	50'	84'	4200
REK	50'	104'	5200

Additional sizes available in 1' increments

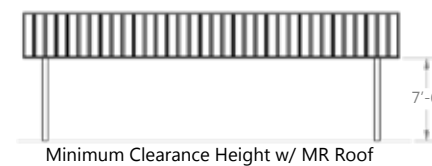
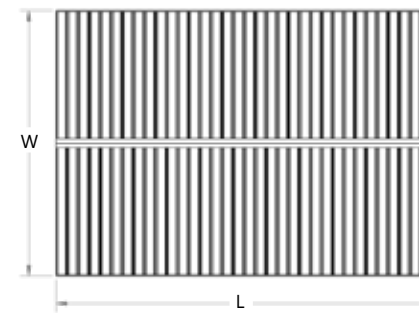

Minimum Clearance Height w/ MR Roof

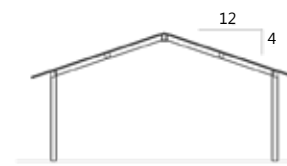

REK 24x34

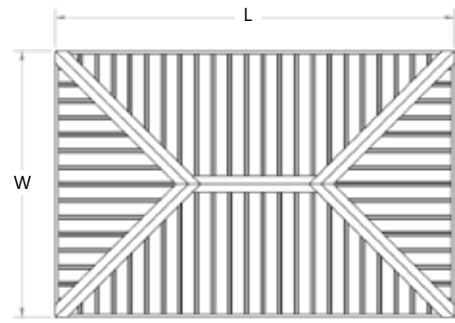

Rectangular Hip Roof

RAM (pg 50-51)

Suggested Sizes

BIN	W	L	SF
RAM	8'	12'	96
RAM	8'	20'	160
RAM	8'	28'	224
RAM	12'	18'	216
RAM	12'	22'	264
RAM	12'	32'	384
RAM	12'	42'	504
RAM	16'	24'	384
RAM	16'	34'	544
RAM	16'	44'	704
RAM	16'	64'	1024
RAM	20'	24'	480
RAM	20'	34'	680
RAM	20'	44'	880
RAM	20'	64'	1280
RAM	24'	34'	816
RAM	24'	44'	1056

BIN	W	L	SF
RAM	24'	64'	1536
RAM	24'	84'	2016
RAM	24'	104'	2496
RAM	30'	34'	1020
RAM	30'	44'	1320
RAM	30'	64'	1920
RAM	30'	84'	2520
RAM	30'	104'	3120
RAM	40'	44'	1760
RAM	40'	64'	2560
RAM	40'	84'	3360
RAM	40'	104'	4160
RAM	50'	64'	3200
RAM	50'	70'	3500
RAM	50'	90'	4500
RAM	50'	110'	5500

Additional sizes available in 1' increments

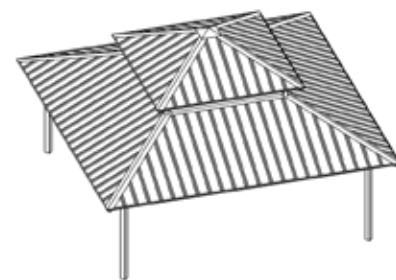
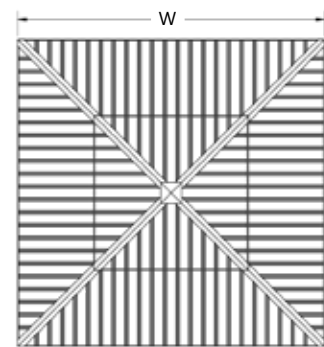
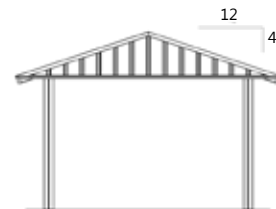
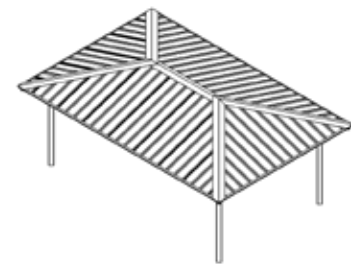

Carnival

CAR (pg 52)

Suggested Sizes

BIN	W	SF
CAR	16'	256
CAR	20'	400
CAR	24'	576
CAR	30'	900
CAR	40'	1600

Additional sizes available in 1' increments

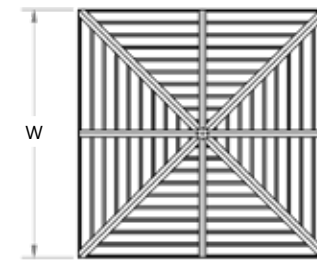
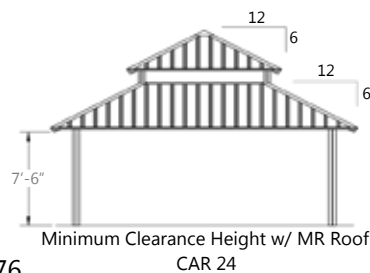

Crossing

CRS (pg 53)

Suggested Sizes

BIN	W	SF
CRS	12'	144
CRS	16'	256
CRS	20'	400
CRS	24'	576
CRS	30'	900

Additional sizes available in 1' increments

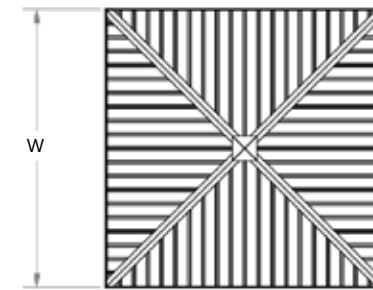
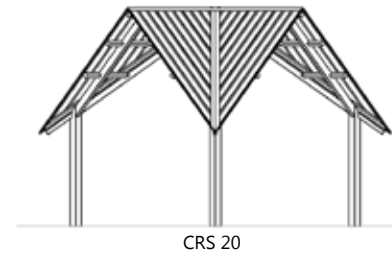
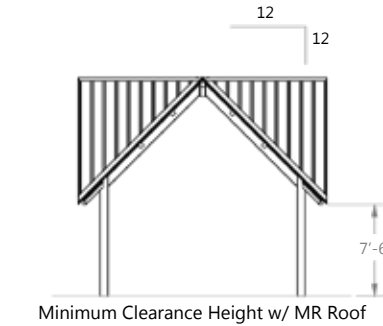

Square

SQR (pg 54-55)

Suggested Sizes

BIN	W	SF
SQR	12'	144
SQR	16'	256
SQR	20'	400
SQR	24'	576
SQR	30'	900
SQR	36'	1296
SQR	40'	1600
SQR	50'	2500

Additional sizes available in 1' increments

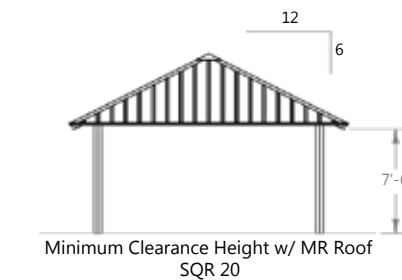

Gable Roof Sun Shelter

SSG (pg 56)

Suggested Sizes

BIN	W	L	SF
SSG	8'	9'	72
SSG	12'	12'	144

Additional sizes available in 1' increments

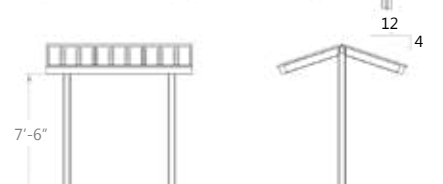
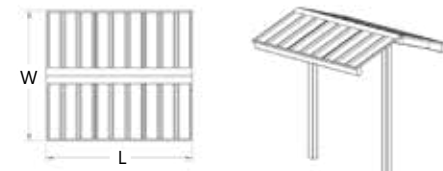

Minimum Clearance Height w/ MR Roof SSG 8x9

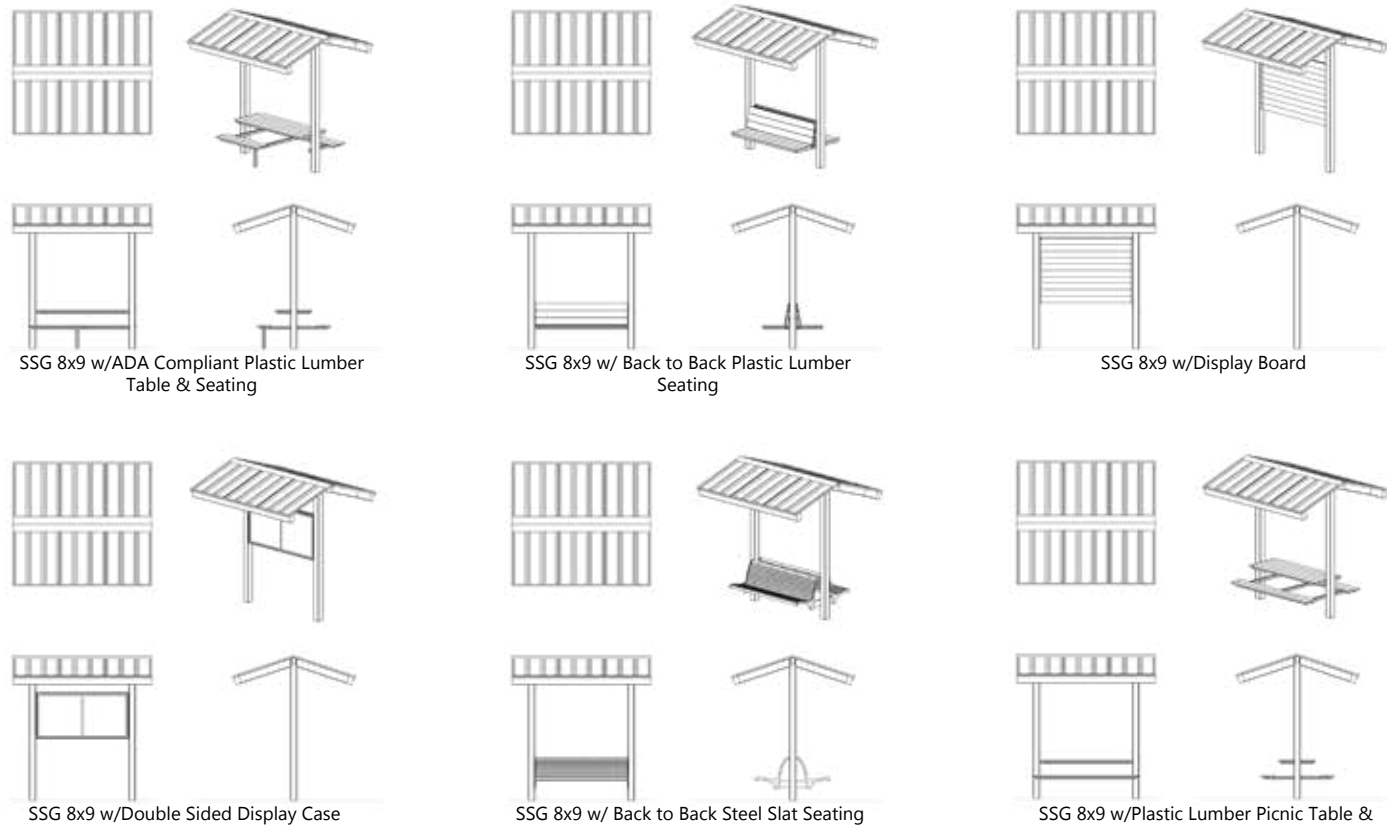

SSG 8x9 w/ADA Compliant Plastic Lumber Table & Seating

SSG 8x9 w/ Back to Back Plastic Lumber Seating

SSG 8x9 w/Display Board

SSG 8x9 w/Double Sided Display Case

SSG 8x9 w/ Back to Back Steel Slat Seating

SSG 8x9 w/Plastic Lumber Picnic Table &

Hip Roof Sun Shelter

SSH (pg 56)

Suggested Sizes

BIN	W	SF
SSG	10'	100
SSG	12'	144

Additional sizes available in 1' increments



SSH 10

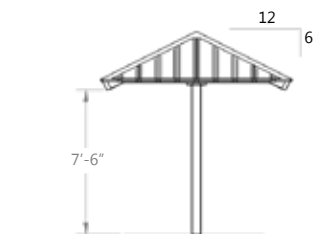

Minimum Clearance Height w/ MR Roof

616.888.3500

Kiosk

KSK (pg 57)

Suggested Sizes

BIN	W	SF
KSK1-8	8'	20
KSK3-8	8'	20

Additional sizes available in 1' increments

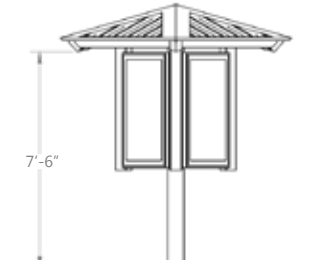
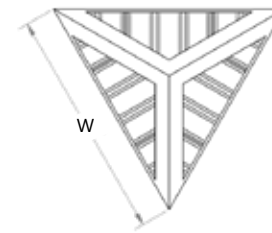

Minimum Clearance Height w/ MR Roof

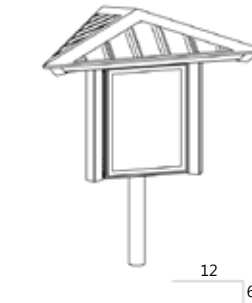

KSK 1-8 Single Column

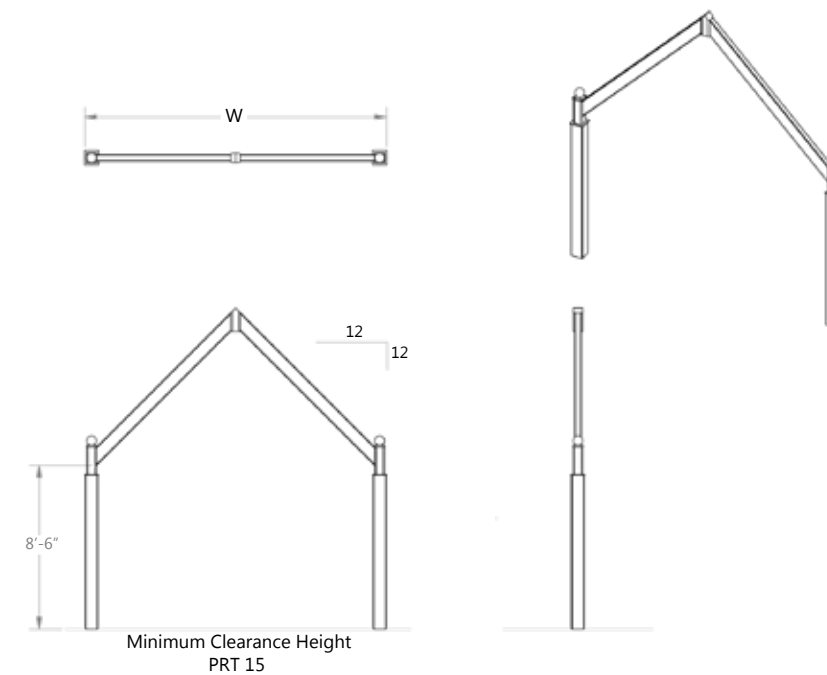

Minimum Clearance Height PRT 15

Portal

PRT (pg 57)

Suggested Sizes

BIN	W
PRT	7'
PRT	11'
PRT	15'
PRT	19'
PRT	23'

Additional sizes available in 1' increments

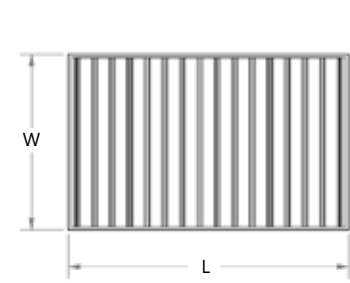

DUG 10x16

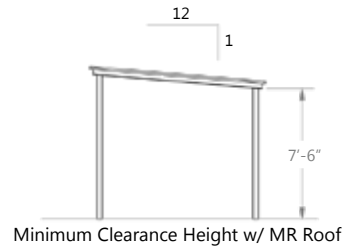

Minimum Clearance Height w/ MR Roof

Dugout

DUG (pg 58)

Suggested Sizes

BIN	W	L	SF
DUG	10'	12'	120
DUG	10'	16'	160
DUG	10'	24'	240
DUG	10'	32'	320
DUG	10'	36'	360
DUG	10'	48'	480

Additional sizes available in 1' increments

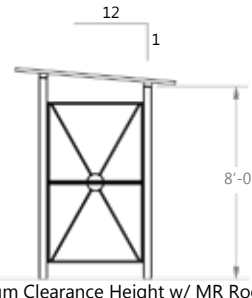
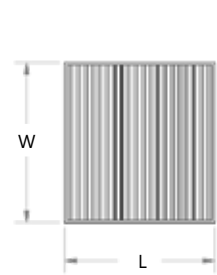

Minimum Clearance Height w/ MR Roof

Privacy Shelter

PRV (pg 59)

Suggested Sizes

BIN	W	L	SF
PRV - S	6.67'	6.33'	42
PRV - D	6.67'	10.5'	70



PRV - S
(Single)

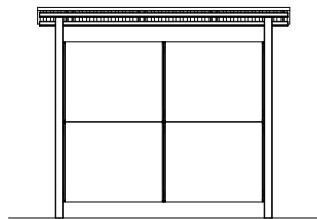

PRV - D
(Double)

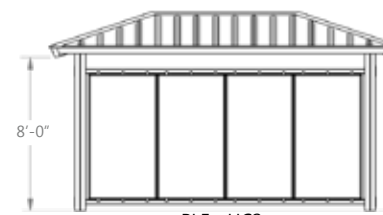
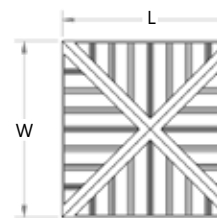

PLE - HC2
Minimum Clearance Height w/ MR Roof

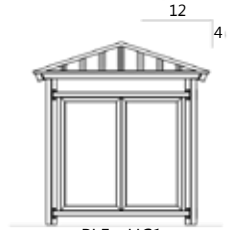

PLE - HC1

Portable Lavatory Enclosure

PLE (pg 59)

BIN	W	L	SF
PLE - HC1	9'	9'	81
PLE - HC2	10'9"	18'4"	197

Additional sizes available in 1' increments

Assembly

Poligon shelters are bolt-together steel frames, with a powder coat finish, that require no field welding. Roof decks are of either metal, tongue and groove, or structural insulated panels (with groove beaded ceiling). Secondary roofing is available in multi-rib, mega-rib, standing seam, or asphalt shingles. This pre-designed package is shipped as a knocked-down pre-fabricated kit that includes the structural frame, roof deck, roofing, fasteners, trim, optional ornamentation and installation instructions. All shelters can be erected quickly when compared to typical construction. Certified Poligon Installers are recommended for the construction. Independent foundations can be designed by Poligon.



Frames are easily bolted together with provided fasteners



No field welding required during erection



Frame complete and ready for roofing



Supporting roof deck is installed



Installation of metal roofing panels



Installation of metal roofing panels

Picnic Table Capacity

The matrices below provide the approximate picnic table capacities for each shelter. Totals were calculated using a standard picnic table size of 5x6. Numbers are approximate and informational only.

Polygonal Shelters

	Hex.	Oct.	Dod.
16'	2	1	
20'	4	4	
24'	5	4	
28'	7	5	
32'	8	8	
40'	14	14	16
48'	22	22	
50'			27
58'	34	36	
60'			41
64'	42	47	
66'			52
86'			79

Rectangular Hip Roof Shelters

	12'	16'	20'	24'	30'	40'	50'
18'	2						
22'	3						
24'		6	7				
34'		8	10	12	16		
42'	6						
44'		12	14	18	20	30	
64'		16	22	25	32	42	56
70'							64
84'				37	40	55	
90'							81
104'				48	52	79	
110'							96

Gable Roof Shelters

	16'	20'	24'	30'	40'	50'
24'	6	7	9			
34'	8	10	12	16		
44'	12	14	18	20	30	
64'	16	22	25	32	42	56
84'		28	37	40	55	73
104'				52	79	90

Square Shelters

	12'	16'	20'	24'	30'	36'	40'	50'
Tables	1	2	6	8	14	20	25	42

Shelter Nomenclature

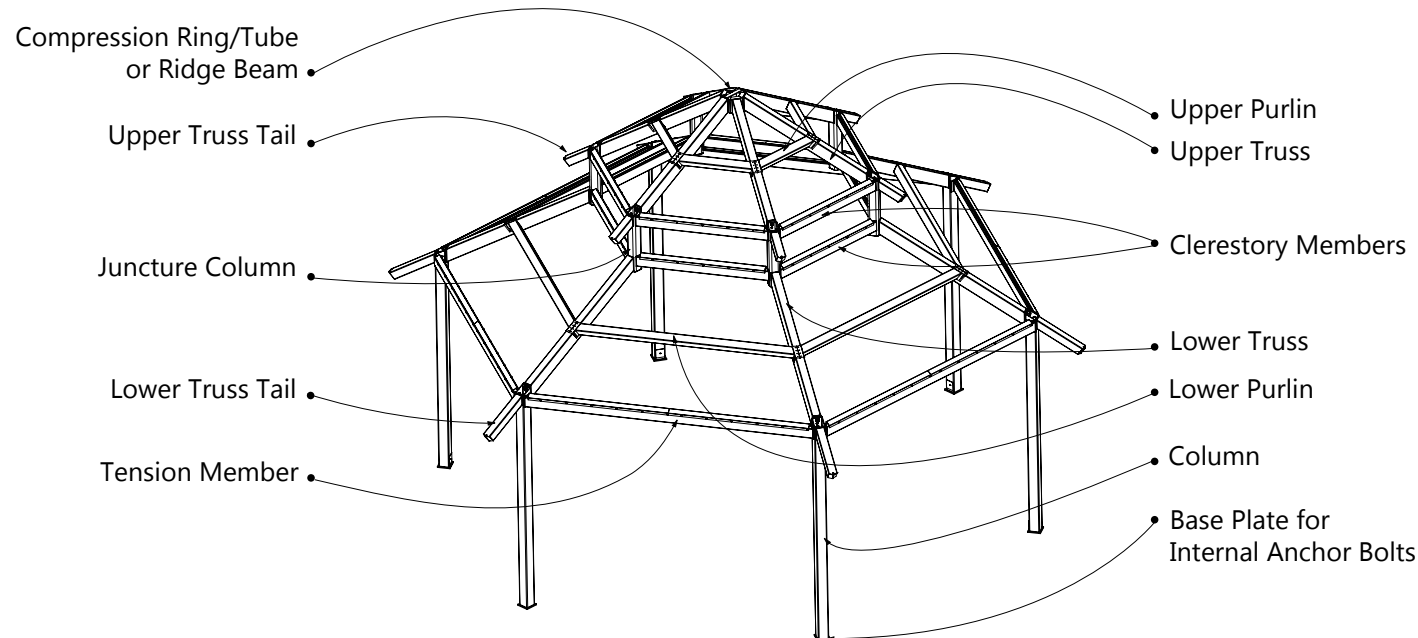

LEED Points

Polygon products can assist your project with LEED certification



What is LEED?

Leadership in Energy and Environmental Design (LEED) is a national standard developed by the United States Green Building Council (USGBC) to certify sustainable buildings. LEED buildings can help save energy, conserve resources, protect occupant health, and improve owners' bottom lines. LEED utilizes a system of points awarded in multiple environmental categories for achieving specific levels of sustainable performance.

LEED Category	Potential Credits												
Location and Transportation (LT) - LT Credit: Bicycle Facilities Provide short-term and long-term bicycle storage for visitors and regular building occupants. Storage amount and proximity to adjacent building varies depending on building usage.	1												
Sustainable Sites (SS) - SS Credit: Heat Island Reduction Option 1: Using roofing materials that have an SRI equal to or greater than the following: <table border="1" style="margin: 10px 0;"> <thead> <tr> <th></th> <th>Slope</th> <th>Initial SRI¹</th> <th>3-year aged SRI¹</th> </tr> </thead> <tbody> <tr> <td>Low-sloped roof</td> <td>≤ 2:12</td> <td>82</td> <td>64</td> </tr> <tr> <td>Steep-sloped roof</td> <td>> 2:12</td> <td>39</td> <td>32</td> </tr> </tbody> </table> Option 2: Place a minimum of 75% of parking spaces under cover with a roof having a 3-year aged SRI of at least 32 ¹ .		Slope	Initial SRI ¹	3-year aged SRI ¹	Low-sloped roof	≤ 2:12	82	64	Steep-sloped roof	> 2:12	39	32	1-2
	Slope	Initial SRI ¹	3-year aged SRI ¹										
Low-sloped roof	≤ 2:12	82	64										
Steep-sloped roof	> 2:12	39	32										
Materials and Resources (MR) - MR Credit: Building Product Disclosure and Optimization – Sourcing of Raw Materials Products with recycled content of at least 20%, by cost, of the total value of permanently installed building products in the project. Recycled content is the sum of the postconsumer recycled content plus one-half the preconsumer recycled content, based on weight ² .	1												
Indoor Environmental Quality (EQ) – EQ Prerequisite: Environmental Tobacco Smoke Control Create designated smoking areas located at least 25 feet from all entries, outdoor air intakes, and operable windows.	N/A												

¹ Certain Polygon roof colors meet this requirement. (Contact customer service or your local sales representative for more information.)

² Contact customer service or your local sales representative for assistance in determining recycled content for your specific project.

Railing & Overhead Ornamentation

Our state-of-the-art laser can custom cut any ornamentation or railing. Please contact your sales representative to discuss other design ideas for your shelter.

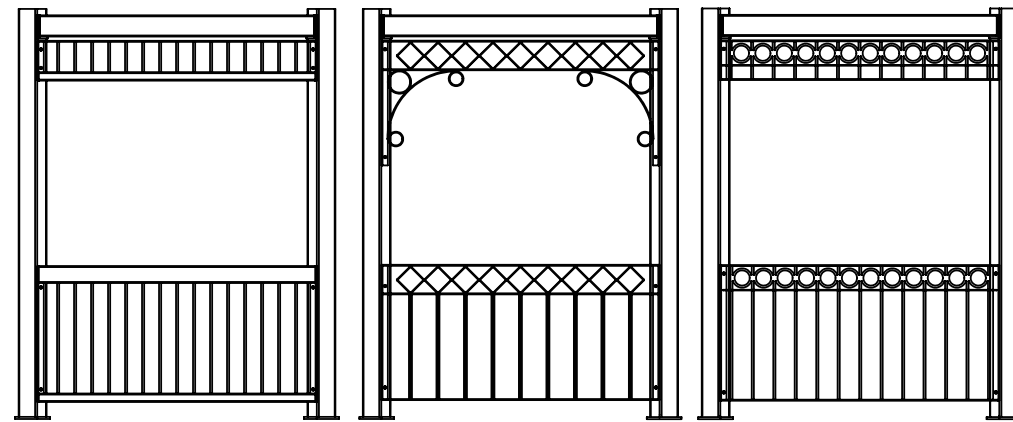

Carmel railing and overhead ornamentation

Diamond railing and overhead ornamentation

Sarasota railing and overhead ornamentation

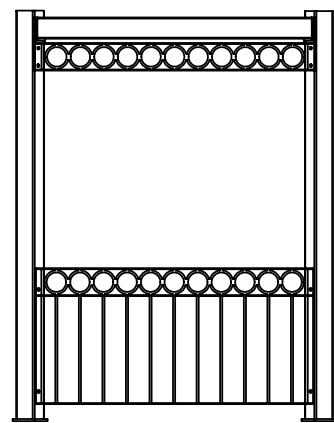

Tampa railing and overhead ornamentation

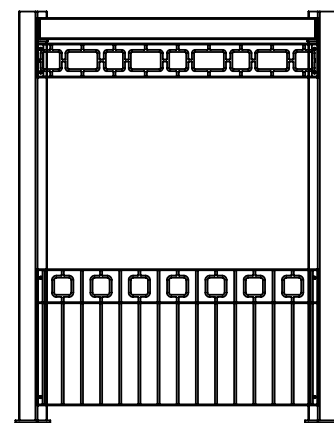

San Jose railing and overhead ornamentation

Standard Stamped Metal Cap

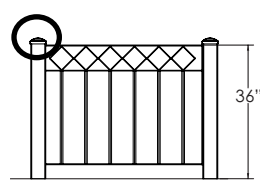

36" Railings

Lower Stanchion with Cast Iron Cap

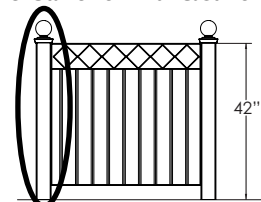

42" Guardrails

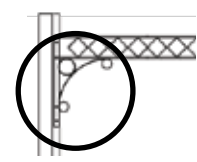

Diamond Corbel

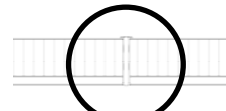

Upper Stanchion w/Cast Cap

Gable Ornamentation

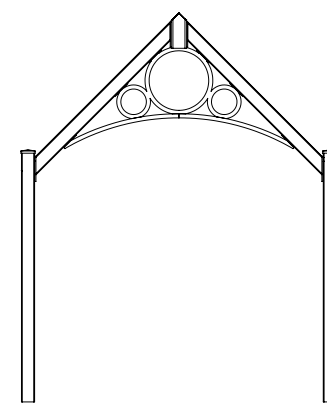

Gable circle ornamentation

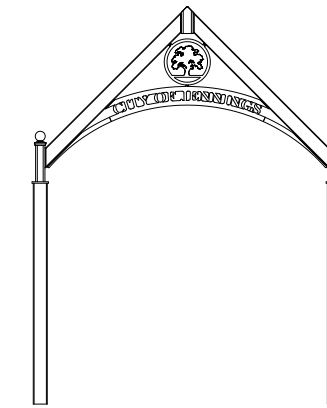

Gable Arch Text & Medallion ornamentation

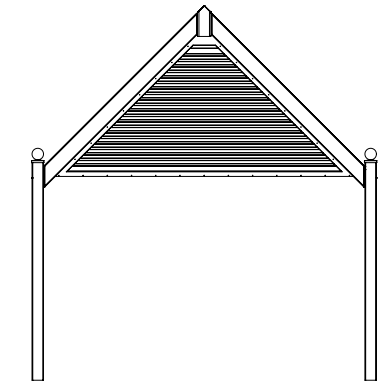

Gable Louver ornamentation

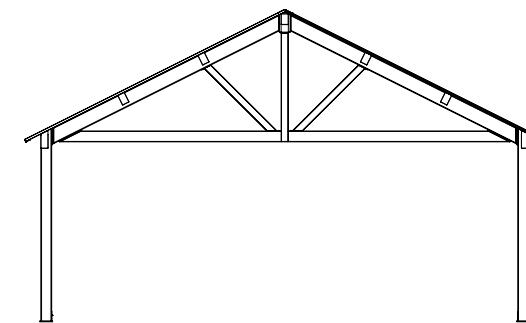

Gable Truss ornamentation

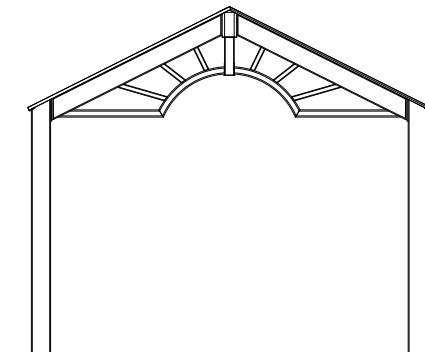

Gable Sunshine ornamentation

Ornamentation Selection

Overhead and Clerestory Ornamentation

Overhead and clerestory ornamentation is available by itself or together with decorative railing and guardrail designs.

36" Railings

Railings are used to accent the shelter design and direct foot traffic throughout.

42" Guardrails

Code-compliant guard rails for instances when a structure's walking surface is more than 30 inches above or below grade.

Upper and Lower Stanchions

Stanchions are required when the ornamentation span exceeds 10 feet. All stanchions come with the standard stamped cap. The cast stanchion cap is optional.

Corbels

Diamond corbels come standard with Diamond overhead ornamentation and are optional for any other style.

Custom Design

To create a unique look, custom design for all ornamentation is available upon request.

Columns

- Columns come in a variety of shapes and sizes. Oversized square, round and rectangular columns are available with or without accent bands
- Not all columns are available on all shelters. Consult Poligon for building specifics
- Columns shown are for illustration only and are not meant to be standards. Bands can be placed in any quantity and most locations on any of the columns
- The maximum height for the column base access holes is 11" (center). Band location must allow the access hole to be placed within the lower 11" of the column
- Column sizes can often be oversized for look but cannot be undersized because of structural requirements
- Stub columns are available for mounting on masonry, bricks or pieces designed by others

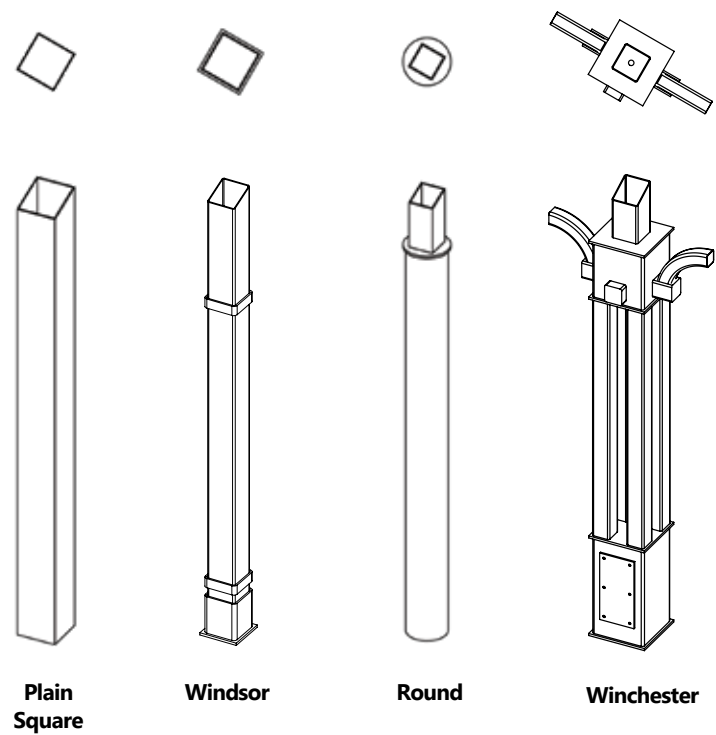

Plain Square **Windsor** **Round** **Winchester**

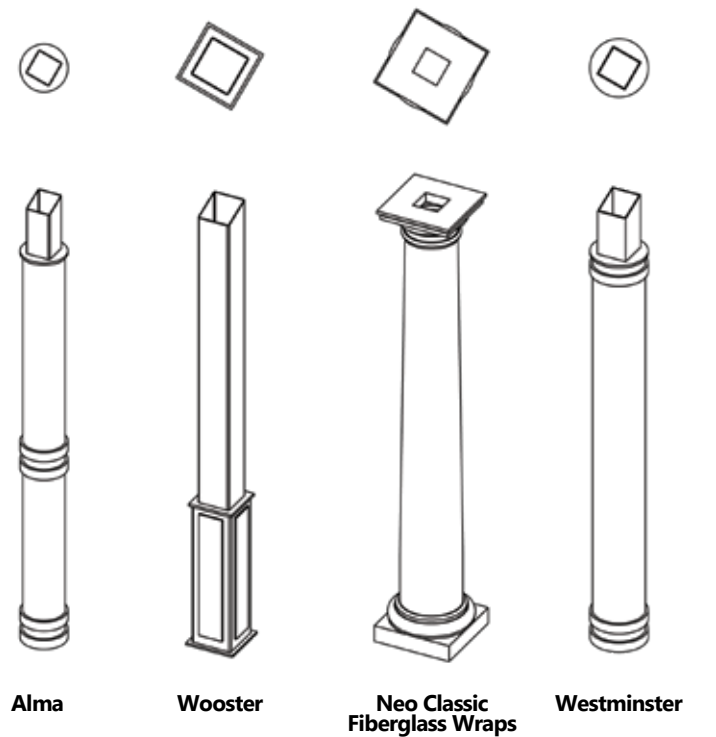

Alma **Wooster** **Neo Classic Fiberglass Wraps** **Westminster**

Anchor Bolt Connections



Internal Anchor Bolts At Finish Grade **Anchor Bolts Below Finish Grade** **External Anchor Bolts At Finish Grade** **External Anchor Bolts With Cover**

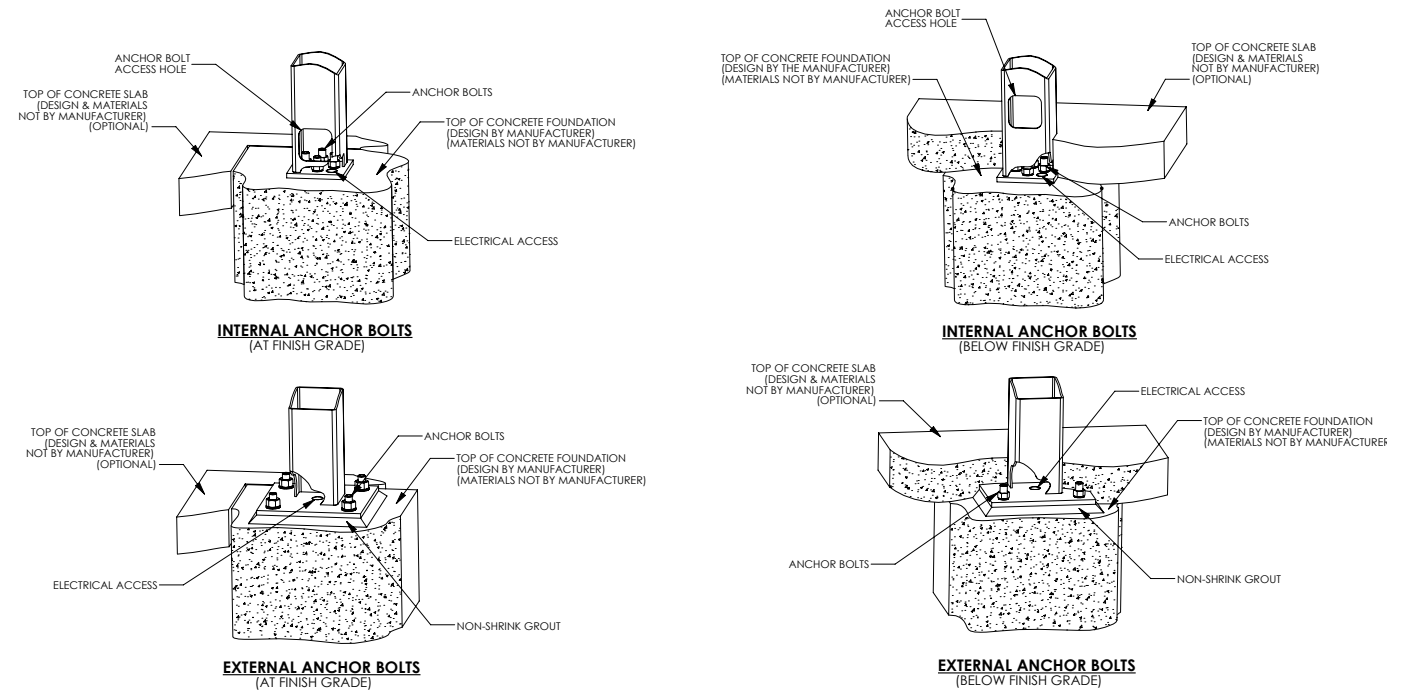

Electrical Cutouts

When electrical access is requested, a 1 1/8" diameter hole is provided through the column baseplate and 3/4" diameter holes are provided through connection plates to allow wire access through columns, trusses, and into the compression ring/tube or ridge beam. Electrical cutouts are round or rectangular holes in structural members required for installation of electrical fixtures or additional wire access. All cutout requests must be reviewed by our engineering department as their placement may affect structural integrity. Poligon is not responsible for unauthorized cutouts made in the field. Unauthorized electrical cutouts made in the field will void the shelter's warranty.

Typical cutout locations:

- Outlet cutouts are typically placed 18" above grade on the inside face of the column
- Light switch cutouts are typically located 48" above grade on the inside face of the column
- All cutouts are at least 12" from any structural joints
- All cutouts are typically centered on the member wall and not close to the corners
- Cutouts can be located through cover plates, such as the bottom of a juncture column
- The standard rectangular cutout size is 2 3/8" x 4" and round cutout size is 3/4" diameter



Poligon Glider

Poligon Gliders provide seating for your structures in a fun new way. Constructed from commercial grade steel, the gliders are both comfortable and modern with horizontal slat seating and clean simple lines.

- Bench length 48" or 72"
- Seat height 19"
- Laser cut and welded end frames 3/8"
- Steel framework 1/4" x 1-1/2"
- Bench weight capacity 600lbs and 850lbs, respectively
- Stops limiting swing travel to 8 degrees fore and aft (16 degrees total)
- 3 year warranty



Glider Frame Ideas:



Equipment Enclosures

Poligon offers equipment enclosures to protect mechanical equipment while providing a safety barrier between patrons and machinery. Each structure is enclosed with perforated paneling that allows both ventilation and privacy. They are also a functional way to mask unsightly equipment from public view. Structures can be adjusted to any size and shape to meet your site needs.

- Screens made from aluminum and powder coated to match steel frame
- Typical hole size is 1/4" diameter but can be adjusted to create various privacy levels and airflow
- Shelters can be designed with various types of entry points, including lockable double doors or by leaving open sections without enclosure panels

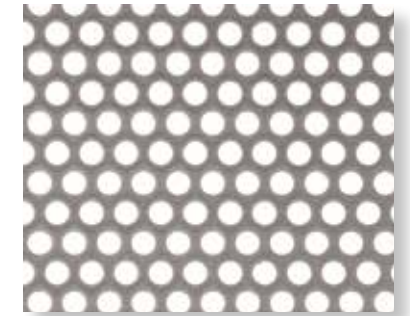

11' x 16' Hip Roof



11' x 16' Monoslope

Low Reveal Clerestory



Standard Reveal Clerestory



Low Reveal Clerestory

Cupolas

Cupolas have a three-letter code system. Each three-letter code (i.e. "CMA") begins with "C" to indicate Cupola, followed by a second letter indicating the style and a third indicating the pitch. Cupola size will be determined by building size, although specific size requests will be accommodated. Please consult with your sales representative for further details. Wood cupolas available upon request.

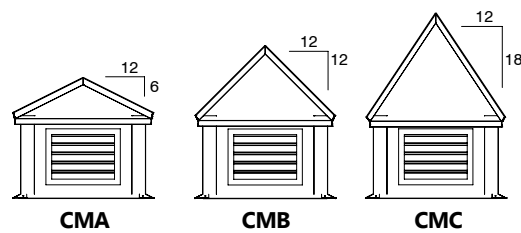

Sheet Metal Non-Venting (Square shown)
Available for Crossing, Gable Ridge, Square, Hexagon, and Octagon shelters.

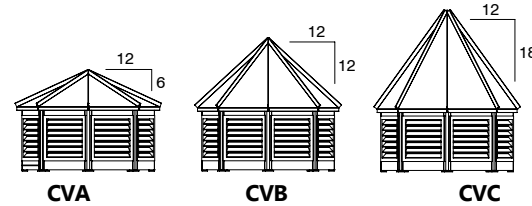

Framed Vented (Octagon shown)
Available for Square, Crossing, Gable Ridge, Hexagon, Octagon, and Dodecagon shelters.

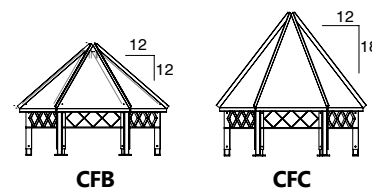

Framed Vented w/ or w/o Ornamentation (Hexagon shown)
Available for Square, Crossing, Gable, Hexagon, Octagon, and Dodecagon shelters. Ornamentation can vary with shelter.

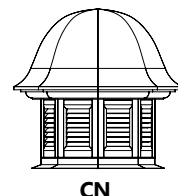

Neo Classic Non-Venting
Available for Square, Hexagon, Octagon, and Dodecagon shelters.

Poli-5000 Powder Coat

Visit our website for current color selection

Poli-5000 is a completely in-house process, performed and overseen by Porter Corp.

Steps include:

- Eight-direction shot blasting of steel to near white condition
- Wash and iron phosphate treatment
- Special epoxy primer powder coat base
- Super Durable TGIC powder top coat
- Baking and curing
- Inspection and packaging

Why Poli-5000?

- Superior performance results over traditional powder coat
- Reduced overall cost and a better finish than field painting over factory applied red oxide primers
- No VOC's with Poli-5000
- More environmentally friendly than liquid paint, ecoat primer, and zinc rich primer systems
- Reliable in-house inspection of all parts
- Upgrade from 'standard' to Super Durable TGIC provides superior color and gloss retention as well as corrosion resistance
- No need for clear top coats (that make touch-up blotchy) when using Super Durable TGIC
- Large offering of 30 standard smooth colors and 9 textured colors

Test Description	Test Method	Poli-5000 Results
Salt Spray Resistance	ASTM B 117/ ASTM D 1654 Method 2 (scraping)	10,000 hours, no creep from scribe line, rating of 10
Humidity	ASTM D2247-02	10,000 hours with no loss of adhesion or blistering
Light UV/ Resistance	ASTM G154-04 2000 hours exposure. Alternate cycles (4 hours UVC and 4 hours condensation)	a) No chalking b) 75% color retention c) Color variation-maximum 3.0 E variation CIE formula (before and after 2,000 hours exposure)
Stain Resistance	ASTM D1308-02e1 24 hours exposure with 10% concentration	No stain from following: Mustard, Tannic Acid, Catsup, Citric Acid, Coffee, Tartaric Acid, Pepsi Cola, Beer, Oleic Acid, Lactic Acid, Orange Juice
Scratch Resistance	Hoffman Scratch Hardness Tester	No substrate appearance with 1,000 gram load
Adhesion	ASTM D3359-02	ASTM Class 4B rating or better
Resistance Impact	ASTM D2794-93	100 in-lbs. w/o cracking
Hardness	ASTM D3363-92a	2H min-no indentation
Flexibility	ASTM D522-93a	1/8" no cracking/loss of adhesion at bend
Abrasion	Taber abraser CS10 Wheel (1,000 mg load)	14 mg. max weight loss per cycle
Solvent Resistance	50+ MEK rubs	Minimal to no dulling or color removal

Poli-5000 Powder Coat

The most durable powder coat finish system in the industry. Steel is shot blasted to a near white condition, given a phosphate wash, coated with an epoxy primer, and then followed with a coat of polyester TGIC powder formulated for maximum UV protection, adhesion, and fade resistance. The Poligon Poli-5000 process is a completely in-house system and is available in a wide range of smooth, textured, and metallic colors.

Galvanized

A basic, long-accepted method of protecting steel from corrosion, galvanizing is the process of coating steel with zinc using a hot bath process. Galvanizing is considered the best corrosion protection process available for steel components and is commonly used where exposure to salt air is anticipated. The galvanizing process results in a random, spangled finish that can also have alternating areas of haze and sheen.

Powder Coat Over Galvanized

The combination of hot dip galvanizing with TGIC powder coating combines the ultimate corrosion protection with the color selection of super-durable powder coating. This long-sought combination has been difficult to successfully achieve but a new proprietary process is now making this finish combination available. Due to the galvanizing process, there will be noticeable texture areas in the final powder coat finish.



Poligon powder coats all exposed washers, nuts, and bolts on every shelter

Roofs & Roofing

Visit our website for current color selection

Metal Roofing

Poligon offers 3 types of metal roof decking for structures. Each one is sourced from McElroy Metal, a trusted vendor partner for over 30 years, and they come standard as 24 gauge with a Kynar 500 factory applied finish. Poligon offers 30 standard colors, with the underside of the decking being off-white. Each profile can be specified for their unique features and benefits. All Poligon roofing options are engineered to required building code. Trim is supplied on all metal roof types.

Multi Rib



- Poligon's most popular and economical roof deck
- Attached to frame with self-tapping screws and gaskets, color matched to roof
- Factory cut panels

Standing Seam



- Offers a flush underside and clean aesthetic (no visible fasteners)
- Cut and hemmed on site by installer
- Standing seam only roofs available in 22 gauge only
- Supporting deck may be required in regions with high wind or snow load requirements

Mega Rib



- Corrugated Profile offers a unique aesthetic for canopies
- Utilized for rolled/curved roof applications

Supporting Roof Deck

Poligon offers supporting roof decks when specified. Supporting roof decks are used to offer both function and style to outdoor structures. The addition of wood warms up the underside of the canopy, while also adding strength, structure, and improved acoustics. Felt is supplied by Poligon.

Tongue & Groove Unstained

- 2x6 Southern Yellow Pine
- Up to 16' lengths are cut to fit on site by installer

Tongue & Groove Stained

- Multiple stain options
- 2x6 Hem Fir
- Up to 16' lengths are cut to fit on site by installer

Structural Insulated Panels (SIPs)

- Provides insulative properties for sound and heat
- Expanded Polystyrene sandwiched between OSB and grooved Douglas Fir siding creating a T&G aesthetic on the underside
- Multiple factory stain options (unstained not available)

Additional Roof Options

Transparent/Translucent



Monolithic Polycarbonate

- Panel with a standing seam and batten system to ensure water will not penetrate
- Available in 6 standard translucent and transparent options
- More economical solution than glass
- Must be installed by certified CPI installer

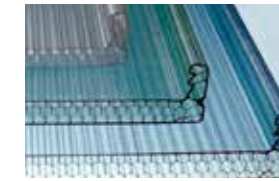

Honeycomb Polycarbonate

- Honeycomb pattern translucent panel
- Used in applications where code or design prohibits monolithic
- More economical than monolithic and lighter than glass
- Must be installed by certified CPI installer



Corrugated Polycarbonate

- Impact resistant and virtually unbreakable
- Blocks 99.9% of harmful UV radiation
- Lightweight – less than half the weight of glass

Decorative



Laser Cut Aluminum Panels

- Various standard patterns
- Many unique powdercoat finishes available
- Fully engineered solution meeting local building code loading requirements

Traditional



Asphalt Architectural Shingles

- 30 Year Warranty
- Traditional aesthetic
- Supporting roof deck required

Trellis Latilla



Steel

- Powdercoated to match the framing
- Sizing can be uniquely specified to enhance aesthetic and shade cast
- 7 end beam design options

Artisan Wood

- Ipe - Brazilian hard wood that provides the most durability
- Mahogany - Adds a unique rich color tone to a trellis
- Cedar - Most economical, available in rough or smooth finish
- Accoya - Engineered wood, lighter natural color
- Multiple end beam design options



poligon[®]
poligon.com

Information, including colors and sizes, subject to change.
Please visit our website for latest options and offerings.

Sourcewell 
Awarded Contract

Visit poligon.com/find-a-rep to find your local Poligon representative who can help get you started on your next Open Air Structure.